

3.3-V PHASE-LOCK LOOP CLOCK DRIVER

FEATURES

- Designed to Meet and Exceed PC133 SDRAM Registered DIMM Specification Rev. 1.1
- Spread Spectrum Clock Compatible
- Operating Frequency 50 MHz to 175 MHz
- Static Phase Error Distribution at 66 MHz to 166 MHz Is ± 125 ps
- Jitter (cyc - cyc) at 66 MHz to 166 MHz Is $|70|$ ps
- Advanced Deep Submicron Process Results in More Than 40% Lower Power Consumption Versus Current Generation PC133 Devices
- Available in Plastic 24-Pin TSSOP
- Phase-Lock Loop Clock Distribution for Synchronous DRAM Applications
- Distributes One Clock Input to One Bank of 10 Outputs
- External Feedback (FBIN) Terminal Is Used to Synchronize the Outputs to the Clock Input
- 25- Ω On-Chip Series Damping Resistors
- No External RC Network Required
- Operates at 3.3 V

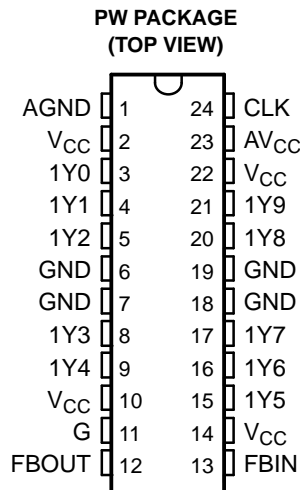

**NOT RECOMMENDED
FOR NEW DESIGNS
USE CDCVF2510A AS
A REPLACEMENT**

DESCRIPTION

The CDCVF2510 is a high-performance, low-skew, low-jitter, phase-lock loop (PLL) clock driver. It uses a phase-lock loop (PLL) to precisely align, in both frequency and phase, the feedback (FBOUT) output to the clock (CLK) input signal. It is specifically designed for use with synchronous DRAMs. The CDCVF2510 operates at a 3.3-V V_{CC}. It also provides integrated series-damping resistors that make it ideal for driving point-to-point loads.

One bank of 10 outputs provides 10 low-skew, low-jitter copies of CLK. Output signal duty cycles are adjusted to 50%, independent of the duty cycle at CLK. Outputs are enabled or disabled via the control (G) input. When the G input is high, the outputs switch in phase and frequency with CLK; when the G input is low, the outputs are disabled to the logic-low state.

Unlike many products containing PLLs, the CDCVF2510 does not require external RC networks. The loop filter for the PLL is included on-chip, minimizing component count, board space, and cost.

Because it is based on PLL circuitry, the CDCVF2510 requires a stabilization time to achieve phase lock of the feedback signal to the reference signal. This stabilization time is required following power up and application of a fixed-frequency, a fixed-phase signal at CLK, or following any changes to the PLL reference or feedback signals. The PLL can be bypassed for test purposes by strapping AV_{CC} to ground.

The CDCVF2510 is characterized for operation from 0°C to 85°C.

For application information see the application reports *High Speed Distribution Design Techniques for CDC509/516/2509/2510/2516* (SLMA003) and *Using CDC2509A/2510A PLL With Spread Spectrum Clocking (SSC)* (SCAA039).



Please be aware that an important notice concerning availability, standard warranty, and use in critical applications of Texas Instruments semiconductor products and disclaimers thereto appears at the end of this data sheet.

FUNCTION TABLE

INPUTS		OUTPUTS	
G	CLK	1Y (0:9)	FBOUT
X	L	L	L
L	H	L	H
H	H	H	H

FUNCTIONAL BLOCK DIAGRAM

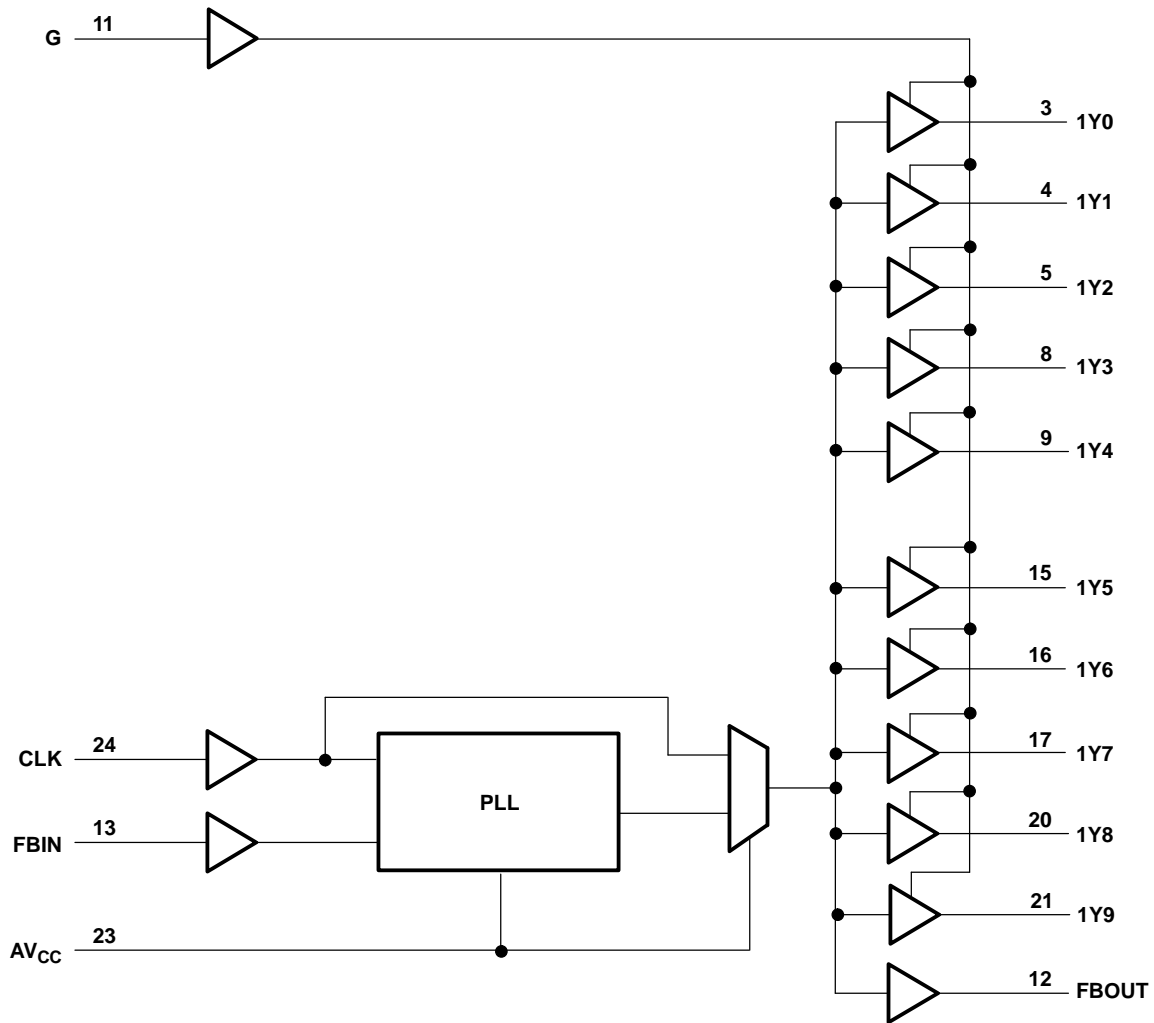

AVAILABLE OPTIONS

T _A	PACKAGE
	SMALL OUTLINE (PW)
0°C to 85°C	CDCVF2510PWR
	CDCVF2510PW

TERMINAL FUNCTIONS

TERMINAL NAME NO.		TYPE	DESCRIPTION
CLK	24	I	Clock input. CLK provides the clock signal to be distributed by the CDCVF2510 clock driver. CLK is used to provide the reference signal to the integrated PLL that generates the clock output signals. CLK must have a fixed frequency and fixed phase for the PLL to obtain phase lock. Once the circuit is powered up and a valid CLK signal is applied, a stabilization time is required for the PLL to phase lock the feedback signal to its reference signal.
FBIN	13	I	Feedback input. FBIN provides the feedback signal to the internal PLL. FBIN must be hard-wired to FBOUT to complete the PLL. The integrated PLL synchronizes CLK and FBIN so that there is nominally zero phase error between CLK and FBIN.
G	11	I	Output bank enable. G is the output enable for outputs 1Y(0:9). When G is low, outputs 1Y(0:9) are disabled to a logic-low state. When G is high, all outputs 1Y(0:9) are enabled and switch at the same frequency as CLK.
FBOUT	12	O	Feedback output. FBOUT is dedicated for external feedback. It switches at the same frequency as CLK. When externally wired to FBIN, FBOUT completes the feedback loop of the PLL. FBOUT has an integrated 25-Ω series-damping resistor.
1Y (0:9)	3, 4, 5, 8, 9, 15, 16, 17, 20, 21	O	Clock outputs. These outputs provide low-skew copies of CLK. Output bank 1Y(0:9) is enabled via the G input. These outputs can be disabled to a logic-low state by deasserting the G control input. Each output has an integrated 25-Ω series-damping resistor.
AV _{CC}	23	Power	Analog power supply. AV _{CC} provides the power reference for the analog circuitry. In addition, AV _{CC} can be used to bypass the PLL for test purposes. When AV _{CC} is strapped to ground, PLL is bypassed and CLK is buffered directly to the device outputs.
AGND	1	Ground	Analog ground. AGND provides the ground reference for the analog circuitry.
V _{CC}	2, 10, 14, 22	Power	Power supply
GND	6, 7, 18, 19	Ground	Ground

ABSOLUTE MAXIMUM RATINGS

over operating free-air temperature range (unless otherwise noted) ⁽¹⁾

		UNIT
AV _{CC} ⁽²⁾	Supply voltage range	AV _{CC} < V _{CC} + 0.7 V
V _{CC}	Supply voltage range	-0.5 V to 4.3 V
V _I ⁽³⁾	Input voltage range	-0.5 V to 4.6 V
V _O ⁽⁴⁾	Voltage range applied to any output in the high or low state	-0.5 V to V _{CC} + 0.5 V
I _{IK} (V _I < 0)	Input clamp current	-50 mA
I _{OK} (V _O < 0 or V _O > V _{CC})	Output clamp current	±50 mA
I _O (V _O = 0 to V _{CC})	Continuous output current	±50 mA
V _{CC} or GND	Continuous current through each	±100 mA
T _A = 55°C (in still air) ⁽⁵⁾	Maximum power dissipation	0.7 W
T _{stg}	Storage temperature range	-65°C to 150°C

(1) Stresses beyond those listed under "absolute maximum ratings" may cause permanent damage to the device. These are stress ratings only and functional operation of the device at these or any other conditions beyond those indicated under "recommended operating conditions" is not implied. Exposure to absolute-maximum-rated conditions for extended periods may affect device reliability.

(2) AV_{CC} must not exceed V_{CC} + 0.7 V.

(3) The input and output negative-voltage ratings may be exceeded if the input and output clamp-current ratings are observed.

(4) This value is limited to 4.6 V maximum.

(5) The maximum package power dissipation is calculated using a junction temperature of 150°C and a board trace length of 750 mils. For more information, see the *Package Thermal Considerations* application note in the *ABT Advanced BiCMOS Technology Data Book* (SCBD002).

DISSIPATION RATING TABLE

PACKAGE	BOARD TYPE ⁽¹⁾	R _{ΘJA}	T _A ≤ 25°C POWER RATING	DERATING FACTOR ⁽²⁾ ABOVE T _A = 25°C	T _A = 70°C POWER RATING	T _A = 85°C POWER RATING
PW	JEDEC low-K	114.5°C/W	920 mW	8.7 mW/°C	520 mW	390 mW
	JEDEC high-K	62.1°C/W	1690 mW	16.1 mW/°C	960 mW	720 mW

- (1) JEDEC high-K board has better thermal performance due to multiple internal copper planes.
(2) This is the inverse of the traditional junction-to-ambient thermal resistance (R_{ΘJA}).

RECOMMENDED OPERATING CONDITIONS ⁽¹⁾

		MIN	MAX	UNIT
V _{CC} , AV _{CC}	Supply voltage	3	3.6	V
V _{IH}	High-level input voltage	2		V
V _{IL}	Low-level input voltage		0.8	V
V _I	Input voltage	0	V _{CC}	V
I _{OH}	High-level output current		-12	mA
I _{OL}	Low-level output current		12	mA
T _A	Operating free-air temperature	0	85	°C

- (1) Unused inputs must be held high or low to prevent them from floating.

TIMING REQUIREMENTS

over recommended ranges of supply voltage and operating free-air temperature

		MIN	MAX	UNIT
f _{clk}	Clock frequency ⁽¹⁾	50	175	MHz
	Input clock duty cycle	40%	60%	
	Stabilization time ⁽²⁾		1	ms

- (1) To avoid any self oscillation of the PLL, a continuous clock signal has to be present at the clock input.
(2) Time required for the integrated PLL circuit to obtain phase lock of its feedback signal to its reference signal. For phase lock to be obtained, a fixed-frequency, fixed-phase reference signal must be present at CLK. Until phase lock is obtained, the specifications for propagation delay, skew, and jitter parameters given in the *Switching Characteristics* table are not applicable. This parameter does not apply for input modulation under SSC application.

ELECTRICAL CHARACTERISTICS

over recommended operating free-air temperature range (unless otherwise noted)

PARAMETER	TEST CONDITIONS	V _{CC} , AV _{CC}	MIN	TYP ⁽¹⁾	MAX	UNIT
V _{IK}	Input clamp voltage	I _I = -18 mA	3 V		-1.2	V
V _{OH}	High-level output voltage	I _{OH} = -100 μA	MIN to MAX	V _{CC} -0.2		V
		I _{OH} = -12 mA	3 V	2.1		
		I _{OH} = -6 mA	3 V	2.4		
V _{OL}	Low-level output voltage	I _{OL} = 100 μA	MIN to MAX		0.2	V
		I _{OL} = 12 mA	3 V		0.8	
		I _{OL} = 6 mA	3 V		0.55	
I _{OH}	High-level output current	V _O = 1 V	3 V	-28		mA
		V _O = 1.65 V	3.3 V		-36	
		V _O = 3.135 V	3.6 V		-8	
I _{OL}	Low-level output current	V _O = 1.95 V	3 V	30		mA
		V _O = 1.65 V	3.3 V		40	
		V _O = 0.4 V	3.6 V		10	
I _I	Input current	V _I = V _{CC} or GND	3.6 V			±5 μA

- (1) For conditions shown as MIN or MAX, use the appropriate value specified under recommended operating conditions.

ELECTRICAL CHARACTERISTICS (continued)

over recommended operating free-air temperature range (unless otherwise noted)

PARAMETER	TEST CONDITIONS	V _{CC} , AV _{CC}	MIN	TYP ⁽¹⁾	MAX	UNIT
I _{CC} ⁽²⁾	Supply current (static, output not switching) V _I = V _{CC} or GND, I _O = 0, Outputs: low or high	3.6 V, 0 V			40	μA
ΔI _{CC}	Change in supply current One input at V _{CC} - 0.6 V, Other inputs at V _{CC} or GND	3.3 V to 3.6 V			500	μA
C _i	Input capacitance V _I = V _{CC} or GND	3.3 V		2.5		pF
C _o	Output capacitance V _O = V _{CC} or GND	3.3 V		2.8		pF

(2) For dynamic I_{CC} vs Frequency, see [Figure 8](#) and [Figure 9](#).

SWITCHING CHARACTERISTICS

over recommended ranges of supply voltage and operating free-air temperature, C_L = 25 pF, See ⁽¹⁾ and [Figure 1](#) and [Figure 2](#)

PARAMETER	FROM (INPUT)	TO (OUTPUT)	V _{CC} , AV _{CC} = 3.3 V ± 0.3 V			UNIT
			MIN	TYP	MAX	
Phase error time-static (normalized), See Figure 3 through Figure 6	CLK↑ = 66 MHz to 166 MHz	FBIN↑	-125		125	ps
t _{sk(o)}	Any Y	Any Y			100	ps
Phase error time-jitter ⁽³⁾	CLK = 66 MHz to 100 MHz	Any Y or FBOUT	-50		50	ps
Jitter _(cycle-to-cycle) : See Figure 7		Any Y or FBOUT		70		
	CLK = 100 MHz to 166 MHz	Any Y or FBOUT		65		ps
Duty cycle	f _(CLK) > 60 MHz	Any Y or FBOUT	45%		55%	
t _r	Rise time V _O = 0.4 V to 2 V	Any Y or FBOUT	0.3		1.1	ns/V
t _f	Fall time V _O = 2 V to 0.4 V	Any Y or FBOUT	0.3		1.1	ns/V
t _{PLH} (bypass mode)	Low-to-high propagation delay time, bypass mode CLK	Any Y or FBOUT	1.8		3.9	ns
t _{PHL} (bypass mode)	High-to-low propagation delay time, bypass mode CLK	Any Y or FBOUT	1.8		3.9	ns

(1) These parameters are not production tested.

(2) The t_{sk(o)} specification is only valid for equal loading of all outputs.

(3) Calculated per PC DRAM SPEC (t_{phase error, static} - jitter_(cycle-to-cycle)).

PARAMETER MEASUREMENT INFORMATION

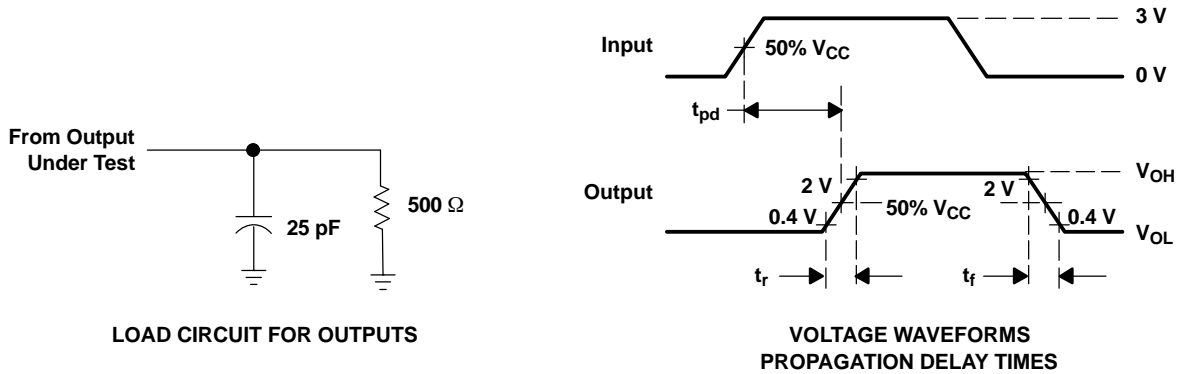

- NOTES: A. C_L includes probe and jig capacitance.
 B. All input pulses are supplied by generators having the following characteristics: $PRR \leq 133$ MHz, $Z_O = 50 \Omega$, $t_r \leq 1.2$ ns, $t_f \leq 1.2$ ns.
 C. The outputs are measured one at a time with one transition per measurement.

Figure 1. Load Circuit and Voltage Waveforms

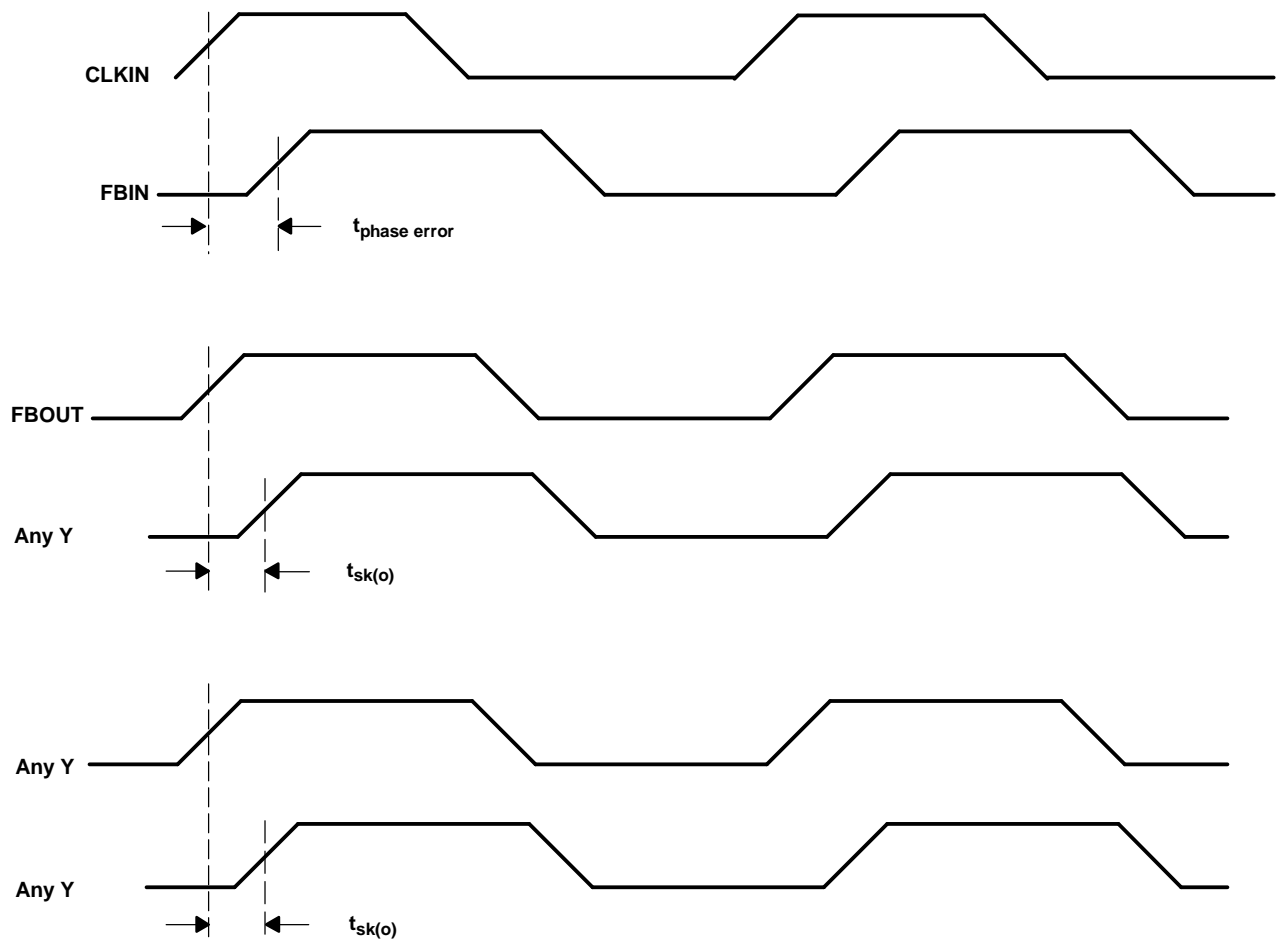

Figure 2. Phase Error and Skew Calculations

TYPICAL CHARACTERISTICS

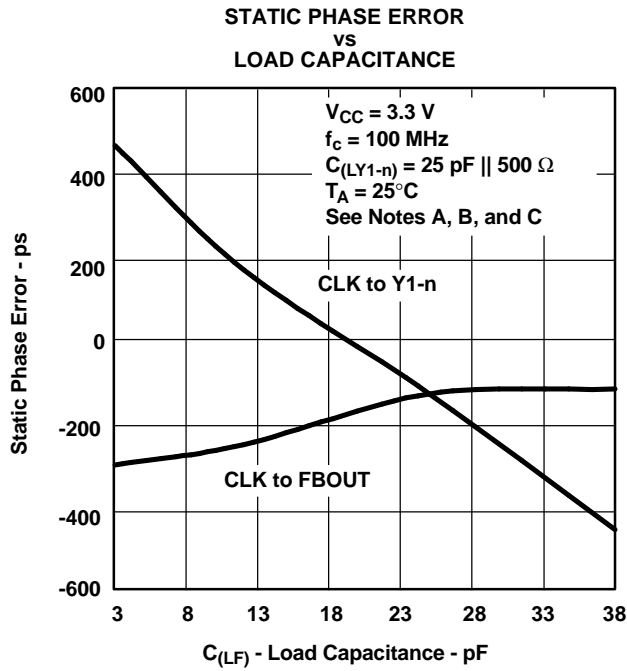

Figure 3.

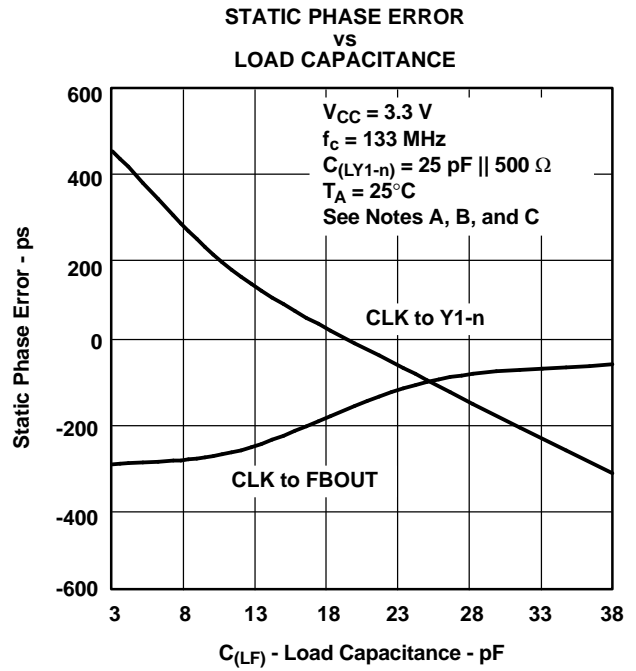

Figure 4.

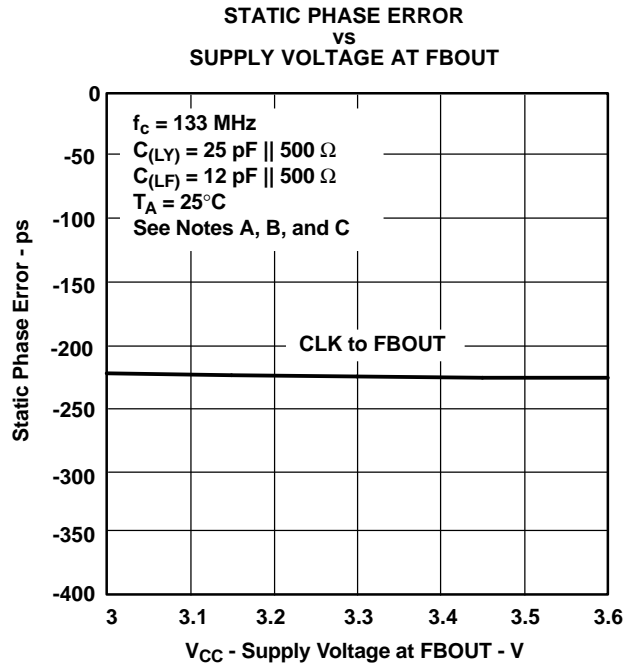

Figure 5.

TYPICAL CHARACTERISTICS (continued)

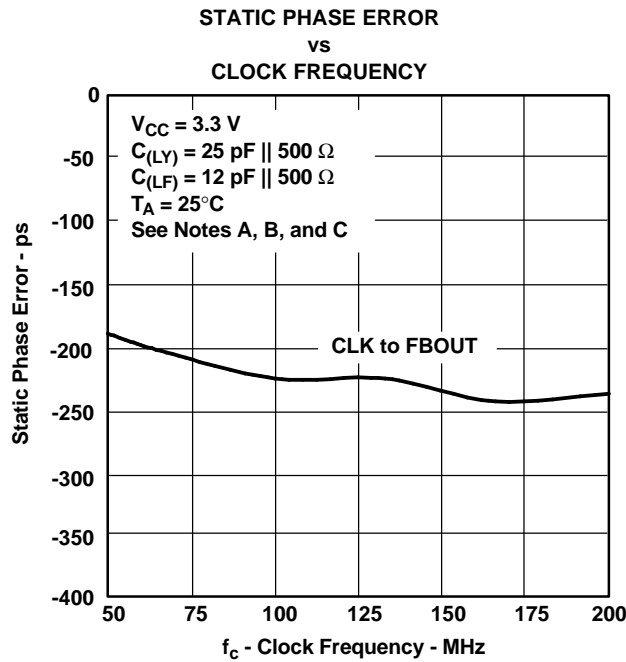

Figure 6.

NOTE:

1. Trace length FBOUT to FBIN = 5 mm, $Z_O = 50 \Omega$
2. $C_{(LY)}$ = Lumped capacitive load Y_{1-n}
3. $C_{(LFx)}$ = Lumped feedback capacitance at FBOUT = FBIN

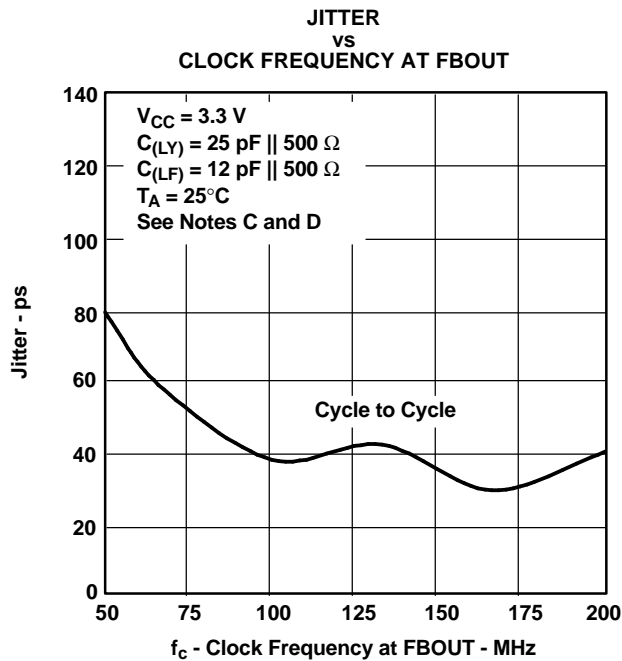

Figure 7.

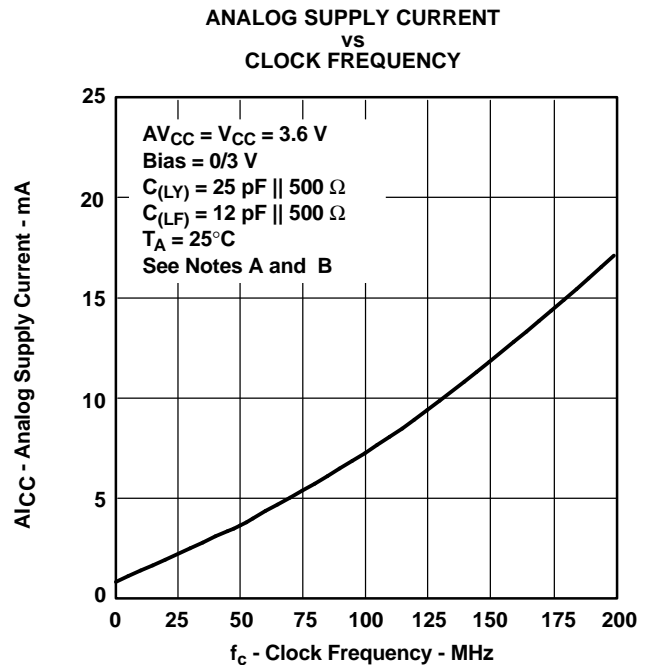
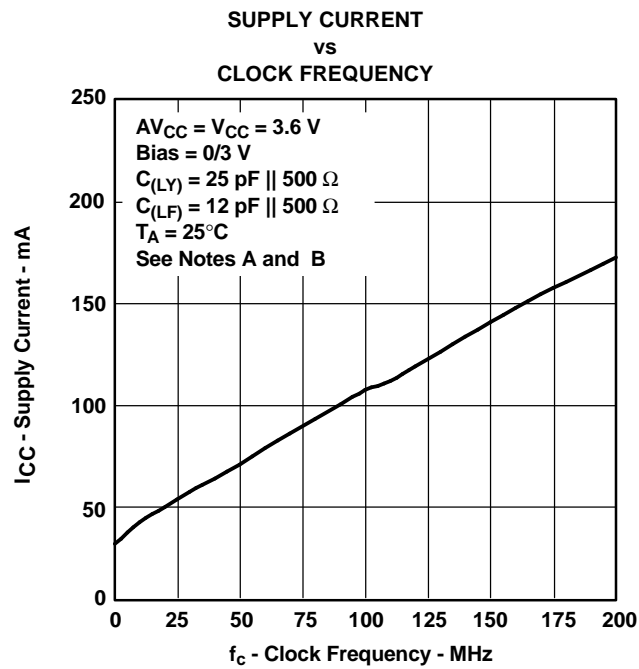

Figure 8.

TYPICAL CHARACTERISTICS (continued)



NOTE:

1. Trace length FBOUT to FBIN = 5 mm, $Z_0 = 50 \Omega$
2. Total current = $I_{CC} + A I_{CC}$
3. $C_{(LY)}$ = Lumped capacitive load Y_{1-n}
4. $C_{(LFx)}$ = Lumped feedback capacitance at FBOUT = FBIN

PACKAGING INFORMATION

Orderable Device	Status ⁽¹⁾	Package Type	Package Drawing	Pins	Package Qty	Eco Plan ⁽²⁾	Lead/Ball Finish	MSL Peak Temp ⁽³⁾
CDCVF2510PW	ACTIVE	TSSOP	PW	24	60	Green (RoHS & no Sb/Br)	CU NIPDAU	Level-1-260C-UNLIM
CDCVF2510PWG4	ACTIVE	TSSOP	PW	24	60	Green (RoHS & no Sb/Br)	CU NIPDAU	Level-1-260C-UNLIM
CDCVF2510PWR	ACTIVE	TSSOP	PW	24	2000	Green (RoHS & no Sb/Br)	CU NIPDAU	Level-1-260C-UNLIM
CDCVF2510PWRG4	ACTIVE	TSSOP	PW	24	2000	Green (RoHS & no Sb/Br)	CU NIPDAU	Level-1-260C-UNLIM

⁽¹⁾ The marketing status values are defined as follows:

ACTIVE: Product device recommended for new designs.

LIFEBUY: TI has announced that the device will be discontinued, and a lifetime-buy period is in effect.

NRND: Not recommended for new designs. Device is in production to support existing customers, but TI does not recommend using this part in a new design.

PREVIEW: Device has been announced but is not in production. Samples may or may not be available.

OBSOLETE: TI has discontinued the production of the device.

⁽²⁾ Eco Plan - The planned eco-friendly classification: Pb-Free (RoHS), Pb-Free (RoHS Exempt), or Green (RoHS & no Sb/Br) - please check <http://www.ti.com/productcontent> for the latest availability information and additional product content details.

TBD: The Pb-Free/Green conversion plan has not been defined.

Pb-Free (RoHS): TI's terms "Lead-Free" or "Pb-Free" mean semiconductor products that are compatible with the current RoHS requirements for all 6 substances, including the requirement that lead not exceed 0.1% by weight in homogeneous materials. Where designed to be soldered at high temperatures, TI Pb-Free products are suitable for use in specified lead-free processes.

Pb-Free (RoHS Exempt): This component has a RoHS exemption for either 1) lead-based flip-chip solder bumps used between the die and package, or 2) lead-based die adhesive used between the die and leadframe. The component is otherwise considered Pb-Free (RoHS compatible) as defined above.

Green (RoHS & no Sb/Br): TI defines "Green" to mean Pb-Free (RoHS compatible), and free of Bromine (Br) and Antimony (Sb) based flame retardants (Br or Sb do not exceed 0.1% by weight in homogeneous material)

⁽³⁾ MSL, Peak Temp. -- The Moisture Sensitivity Level rating according to the JEDEC industry standard classifications, and peak solder temperature.

Important Information and Disclaimer:The information provided on this page represents TI's knowledge and belief as of the date that it is provided. TI bases its knowledge and belief on information provided by third parties, and makes no representation or warranty as to the accuracy of such information. Efforts are underway to better integrate information from third parties. TI has taken and continues to take reasonable steps to provide representative and accurate information but may not have conducted destructive testing or chemical analysis on incoming materials and chemicals. TI and TI suppliers consider certain information to be proprietary, and thus CAS numbers and other limited information may not be available for release.

In no event shall TI's liability arising out of such information exceed the total purchase price of the TI part(s) at issue in this document sold by TI to Customer on an annual basis.

TAPE AND REEL BOX INFORMATION

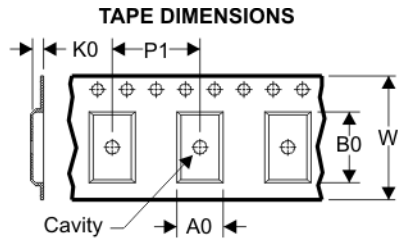
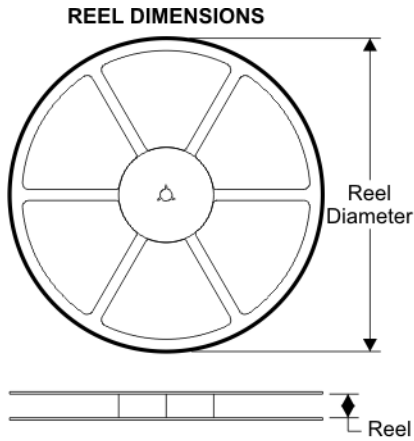

A0	Dimension designed to accommodate the component width
B0	Dimension designed to accommodate the component length
K0	Dimension designed to accommodate the component thickness
W	Overall width of the carrier tape
P1	Pitch between successive cavity centers

QUADRANT ASSIGNMENTS FOR PIN 1 ORIENTATION IN TAPE

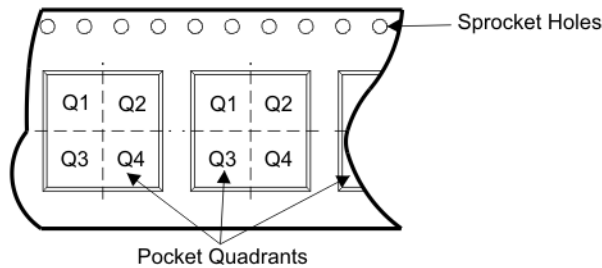

Device	Package	Pins	Site	Reel Diameter (mm)	Reel Width (mm)	A0 (mm)	B0 (mm)	K0 (mm)	P1 (mm)	W (mm)	Pin1 Quadrant
CDCVF2510PWR	PW	24	SITE 41	330	16	6.95	8.3	1.6	8	16	Q1

TAPE AND REEL BOX DIMENSIONS



Device	Package	Pins	Site	Length (mm)	Width (mm)	Height (mm)
CDCVF2510PWR	PW	24	SITE 41	346.0	346.0	33.0

PW (R-PDSO-G**)

PLASTIC SMALL-OUTLINE PACKAGE

14 PINS SHOWN



4040064/F 01/97

- NOTES: A. All linear dimensions are in millimeters.
 B. This drawing is subject to change without notice.
 C. Body dimensions do not include mold flash or protrusion not to exceed 0,15.
 D. Falls within JEDEC MO-153

IMPORTANT NOTICE

Texas Instruments Incorporated and its subsidiaries (TI) reserve the right to make corrections, modifications, enhancements, improvements, and other changes to its products and services at any time and to discontinue any product or service without notice. Customers should obtain the latest relevant information before placing orders and should verify that such information is current and complete. All products are sold subject to TI's terms and conditions of sale supplied at the time of order acknowledgment.

TI warrants performance of its hardware products to the specifications applicable at the time of sale in accordance with TI's standard warranty. Testing and other quality control techniques are used to the extent TI deems necessary to support this warranty. Except where mandated by government requirements, testing of all parameters of each product is not necessarily performed.

TI assumes no liability for applications assistance or customer product design. Customers are responsible for their products and applications using TI components. To minimize the risks associated with customer products and applications, customers should provide adequate design and operating safeguards.

TI does not warrant or represent that any license, either express or implied, is granted under any TI patent right, copyright, mask work right, or other TI intellectual property right relating to any combination, machine, or process in which TI products or services are used. Information published by TI regarding third-party products or services does not constitute a license from TI to use such products or services or a warranty or endorsement thereof. Use of such information may require a license from a third party under the patents or other intellectual property of the third party, or a license from TI under the patents or other intellectual property of TI.

Reproduction of TI information in TI data books or data sheets is permissible only if reproduction is without alteration and is accompanied by all associated warranties, conditions, limitations, and notices. Reproduction of this information with alteration is an unfair and deceptive business practice. TI is not responsible or liable for such altered documentation. Information of third parties may be subject to additional restrictions.

Resale of TI products or services with statements different from or beyond the parameters stated by TI for that product or service voids all express and any implied warranties for the associated TI product or service and is an unfair and deceptive business practice. TI is not responsible or liable for any such statements.

TI products are not authorized for use in safety-critical applications (such as life support) where a failure of the TI product would reasonably be expected to cause severe personal injury or death, unless officers of the parties have executed an agreement specifically governing such use. Buyers represent that they have all necessary expertise in the safety and regulatory ramifications of their applications, and acknowledge and agree that they are solely responsible for all legal, regulatory and safety-related requirements concerning their products and any use of TI products in such safety-critical applications, notwithstanding any applications-related information or support that may be provided by TI. Further, Buyers must fully indemnify TI and its representatives against any damages arising out of the use of TI products in such safety-critical applications.

TI products are neither designed nor intended for use in military/aerospace applications or environments unless the TI products are specifically designated by TI as military-grade or "enhanced plastic." Only products designated by TI as military-grade meet military specifications. Buyers acknowledge and agree that any such use of TI products which TI has not designated as military-grade is solely at the Buyer's risk, and that they are solely responsible for compliance with all legal and regulatory requirements in connection with such use.

TI products are neither designed nor intended for use in automotive applications or environments unless the specific TI products are designated by TI as compliant with ISO/TS 16949 requirements. Buyers acknowledge and agree that, if they use any non-designated products in automotive applications, TI will not be responsible for any failure to meet such requirements.

Following are URLs where you can obtain information on other Texas Instruments products and application solutions:

Products		Applications	
Amplifiers	amplifier.ti.com	Audio	www.ti.com/audio
Data Converters	dataconverter.ti.com	Automotive	www.ti.com/automotive
DSP	dsp.ti.com	Broadband	www.ti.com/broadband
Interface	interface.ti.com	Digital Control	www.ti.com/digitalcontrol
Logic	logic.ti.com	Military	www.ti.com/military
Power Mgmt	power.ti.com	Optical Networking	www.ti.com/opticalnetwork
Microcontrollers	microcontroller.ti.com	Security	www.ti.com/security
RFID	www.ti-rfid.com	Telephony	www.ti.com/telephony
Low Power Wireless	www.ti.com/lpw	Video & Imaging	www.ti.com/video
		Wireless	www.ti.com/wireless

Mailing Address: Texas Instruments, Post Office Box 655303, Dallas, Texas 75265
Copyright © 2007, Texas Instruments Incorporated