

Silicon PIN Diode

- High voltage current controlled
RF resistor for RF attenuator and switches
- Frequency range above 1 MHz up to 3 GHz
- Low resistance and long carrier lifetime
- Very low capacitance at zero volts reverse bias at frequencies above 1 GHz
- Very low signal distortion
- Extremely small plastic SMD package

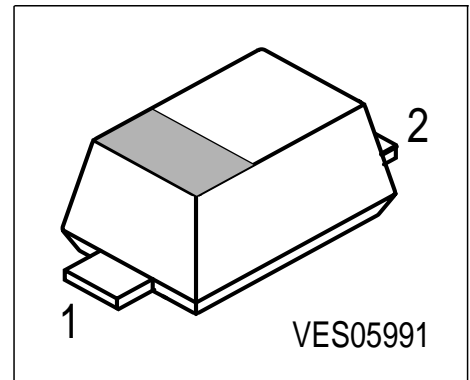

Type	Marking	Pin Configuration		Package
BAR64-02W	M	1 = C	2 = A	SCD80

Maximum Ratings

Parameter	Symbol	Value	Unit
Diode reverse voltage	V_R	150	V
Forward current	I_F	100	mA
Total power dissipation, $T_S \leq 125^\circ\text{C}$	P_{tot}	250	mW
Junction temperature	T_j	150	$^\circ\text{C}$
Operating temperature range	T_{op}	-55 ... 150	$^\circ\text{C}$
Storage temperature	T_{stg}	-55 ... 150	

Thermal Resistance

Junction - soldering point ¹⁾	R_{thJS}	≤ 140	K/W
--	-------------------	------------	-----

¹⁾For calculation of R_{thJA} please refer to Application Note Thermal Resistance

Electrical Characteristics at $T_A = 25\text{ }^\circ\text{C}$, unless otherwise specified.

Parameter	Symbol	Values			Unit
		min.	typ.	max.	
Characteristics					
Breakdown voltage $I_{(BR)} = 5\text{ }\mu\text{A}$	$V_{(BR)}$	150	-	-	V
Forward voltage $I_F = 50\text{ mA}$	V_F	-	-	1.1	
AC characteristics					
Diode capacitance $V_R = 20\text{ V}, f = 1\text{ MHz}$	C_T	-	0.23	0.35	pF
Case capacitance $f = 1\text{ MHz}$	C_C	-	0.09	-	
Forward resistance $I_F = 1\text{ mA}, f = 100\text{ MHz}$ $I_F = 10\text{ mA}, f = 100\text{ MHz}$ $I_F = 100\text{ mA}, f = 100\text{ MHz}$	r_f	-	12.5 2.1 0.85	20 3.8 1.35	Ω
Charge carrier life time $I_F = 10\text{ mA}, I_R = 6\text{ mA}, I_R = 3\text{ mA}$	τ_{rr}	-	1.55	-	
Series inductance	L_S	-	0.6	-	

Forward current $I_F = f(T_S)$

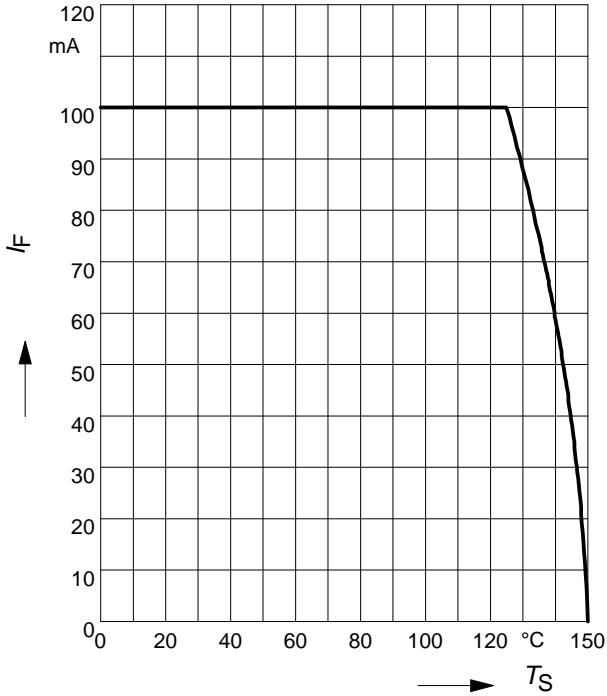

Permissible Pulse Load $R_{thJS} = f(t_p)$

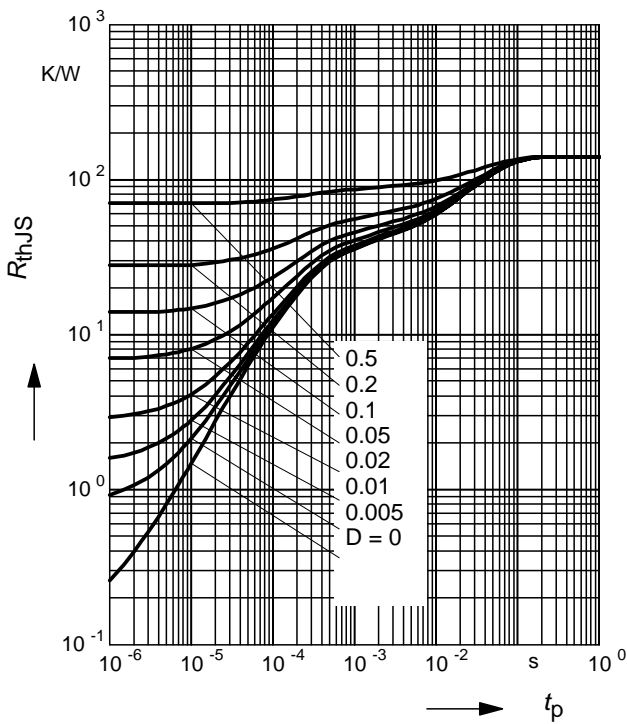

Permissible Pulse Load

$I_{Fmax} / I_{FDC} = f(t_p)$

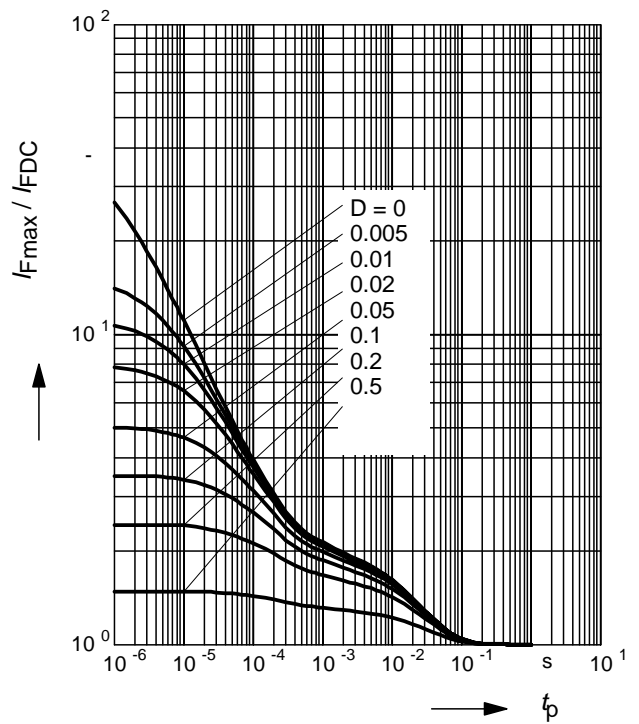

Diode capacitance $C_T = f(V_R)$

$f = 1\text{MHz}$

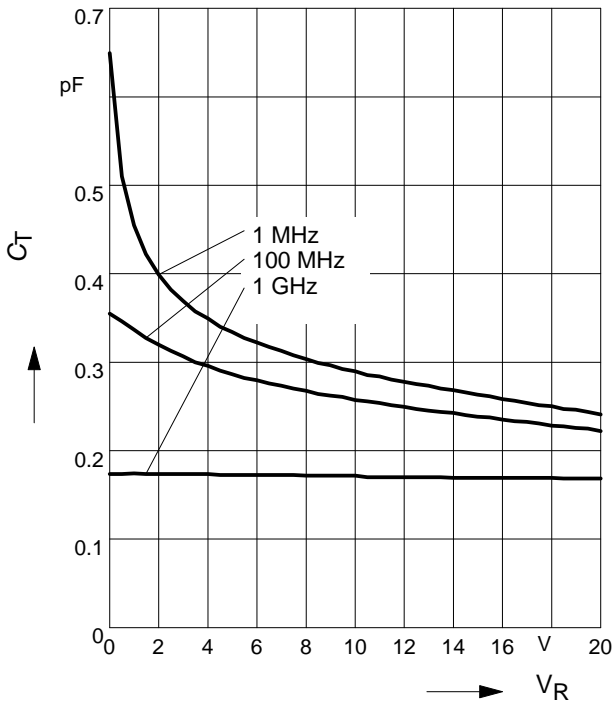

Forward resistance $r_f = f(I_F)$

$f = 100\text{MHz}$

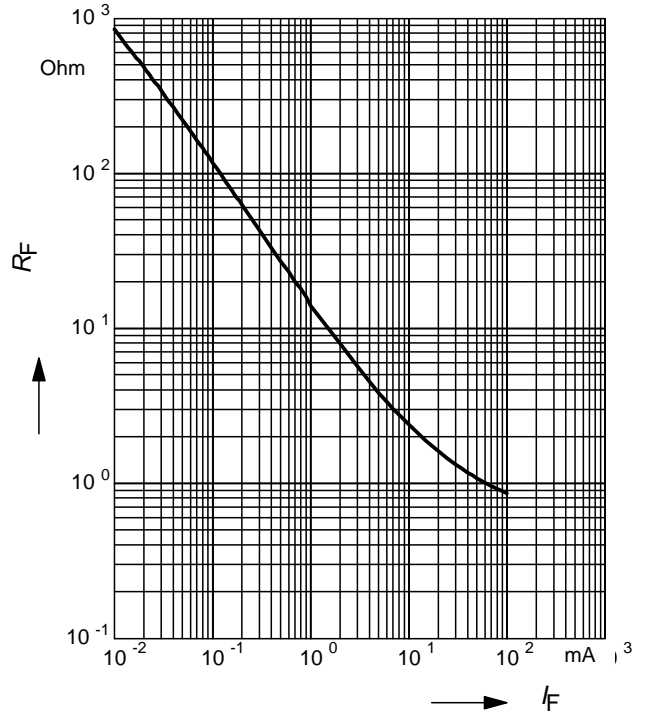

Forward current $I_F = f(V_F)$

$T_A = 25^\circ\text{C}$

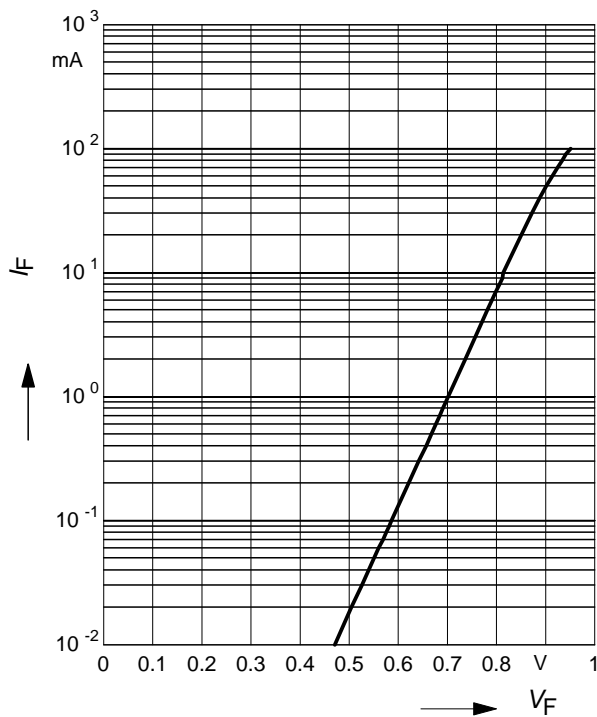

Intermodulation intercept point $IP_3 = f(I_F)$

$f = \text{parameter}$

