

Features

- Programmability
- Low offset voltage—4 mV (EHA2400A)
- High slew rate—30 V/ μ s
- Wide gain bandwidth—40 MHz
- High gain—150,000 V/V
- Low offset current—5 nA
- High input impedance—30 M Ω
- Low crosstalk— -110 dB
- Single capacitor compensation
- Short circuit protected output
- DTL/TTL/CMOS compatible digital inputs

Applications

- Analog signal selection/multiplexing
- Op amp gain selection, P.G.A.
- Add-subtract functions
- Filter characteristic programmability
- Integrator characteristic selection
- Comparator level control
- Adjustable frequency oscillators

Ordering Information

Part No.	Temp. Range	Pkg.	Outline #
EHA1-2400-2	-55°C to +125°C	CerDIP	MDP0021
EHA1-2400/883B	-55°C to +125°C	CerDIP	MDP0021
EHA1-2405-5	0°C to +75°C	CerDIP	MDP0021
EHA1-2400A-2	-55°C to +125°C	CerDIP	MDP0021
EHA1-2400A/883B	-55°C to +125°C	CerDIP	MDP0021
EHA1-2405A-5	0°C to +75°C	CerDIP	MDP0021

5962-87783 is the SMD version of this device.

Truth Table

D1	D0	EN	Selected Channel
L	L	H	1
L	H	H	2
H	L	H	3
H	H	H	4
X	X	L	None

General Description

The EHA2400/2400A/2405/2405A is a series of versatile four-channel high-speed programmable monolithic amplifiers. They have four operational amplifier channels, any one of which may be electronically selected and connected to a single output stage through DTL/TTL/CMOS compatible address inputs. The device formed by the output and the selected pair of differential inputs is an op amp which delivers excellent slew rate, gain bandwidth and power bandwidth performance. For higher accuracy applications, the EHA2400A and EHA2405A have a tightened input offset voltage specification of 4 mV maximum. Other features of these Complementary Bipolar amplifiers include high voltage gain and input impedance coupled with low input offset voltage and offset current. External compensation is not required on this device at closed loop gains of 10 or more, and all four channels of the device are compensated for unity gain with a single 15 pF capacitor. The compensation pin may also be used to limit the output swing through suitable clamping diodes. Elantec's careful design of the front end makes possible an "A" version with 4 mV maximum of input offset voltage.

Each channel of the EHA2400/2400A/2405/2405A can be controlled and operated with suitable feedback networks in any of the standard op amp configurations. This ability makes these amplifiers excellent components for multiplexing, signal selection, mathematical function designs, signal generators, active filters, and data acquisition designs.

Elantec's EHA2400/883B and EHA2400A/883B comply with MIL-STD-883 Revision C in all aspects. Elantec's facilities comply with MIL-I-45208A and other applicable quality specifications. For information on Elantec's military processing, see the Elantec document, QRA-2: *Elantec's Military Processing-Monolithic Products.*

Connection Diagram

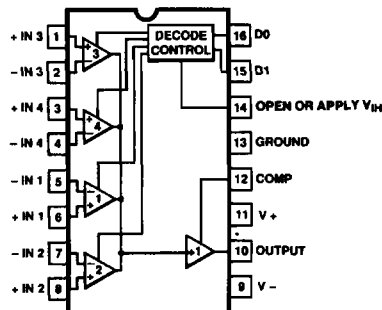

2400-1

EHA2400 Series

4 Channel Programmable Amp

Absolute Maximum Ratings

Voltage between V+ and V-	45V	T _A	Operating Temperature Range
Differential Input Voltage	± V Supply		EHA2400A, EHA2400 -55°C ≤ T _A ≤ +125°C
Output Current	Short Circuit Protected		EHA2405A, EHA2405 0°C ≤ T _A ≤ +75°C
Internal Power Dissipation	(See Curves)		Storage Temperature Range -65°C ≤ T _A ≤ +150°C
			Maximum Junction Temperature 175°C

Important Note:

All parameters having Min/Max specifications are guaranteed. The Test Level column indicates the specific device testing actually performed during production and Quality Inspection. Elantec performs most electrical tests using modern high-speed automatic test equipment, specifically the LTX77 Series system. Unless otherwise noted, all tests are pulsed tests, therefore T_J = T_C = T_A.

Test Level	Test Procedure
I	100% production tested and QA sample tested per QA test plan QCX0002.
II	100% production tested at T _A = 25°C and QA sample tested at T _A = 25°C, T _{MAX} and T _{MIN} per QA test plan QCX0002.
III	QA sample tested per QA test plan QCX0002.
IV	Parameter is guaranteed (but not tested) by Design and Characterization Data.
V	Parameter is typical value at T _A = 25°C for information purposes only.

DC Electrical Characteristics V_S = ±15V, R_L = 2 kΩ, unless otherwise specified.

V_{IL} +0.5V, V_{IH} = +2.4V, limits apply to each of the four channels, when addressed.

Parameter	Description	Test Conditions	Temp	EHA2400/A				EHA2405/A				Units
				Min	Typ	Max	Test Level	Min	Typ	Max	Test Level	
V _{OS}	Offset Voltage	(EHA2400A/ EHA2405A)*	25°C		0.5	4*	I		0.5	4*	I	mV
			Full			6*	I			6*	III	mV
V _{OS}	Offset Voltage	(EHA2400/ EHA2405)	25°C		4	9	I		4	9	I	mV
			Full			11	I			11	III	mV
I _B	Bias Current (Note 1)		25°C		50	200	I		50	250	I	nA
			Full			400	I			500	III	nA
I _{OS}	Offset Current (Note 1)		25°C		5	50	I		5	50	I	nA
			Full			100	I			100	III	nA
R _{IN}	Input Resistance (Note 1)		25°C		30		V		30		V	MΩ
V _{CM}	Common Mode Range		Full	±9			I	±9			II	V
A _V	Large Signal Voltage Gain (Note 2)		±25°C	50k	150k		I	50k	150k		I	V/V
			Full	25k			I	25k			III	V/V
CMRR	Common-Mode Rejection Ratio (Note 3)		Full	80	100		I	74	100		II	dB
V _O	Output Voltage Swing		Full	±10	±12		I	±10	±12		II	V
I _O	Output Current (Note 2)		±25°C	±10	±20		I	±10	±20		I	mA
I _S	Supply Current		25°C		4.8	6.0	I		4.8	6.0	I	mA
PSRR	Power Supply Rejection Ratio (Note 5)		Full	74	90		I	74	90		II	dB

(* = Preliminary Specification)

EHA2400 Series

4 Channel Programmable Amp

EHA2400 SERIES

Channel Select Characteristics

Parameter	Description	Test Conditions	Temp	EHA2400/A				EHA2405/A				Units
				Min	Typ	Max	Test Level	Min	Typ	Max	Test Level	
I _{INL}	Digital Input Current	V _{IN} = 0V	Full		0.1	1.5	I		0.1	1.5	II	mA
I _{INH}	Digital Input Current	V _{IN} = +5V	Full		5		V		5		V	nA
CT	Crosstalk (Note 7)		25°C	-80	-110		I	-74	-110		I	dB

AC Electrical Characteristics $V_S = \pm 15V$, $R_L = 2\text{ k}\Omega$, unless otherwise specified.

V_{IL} = +0.5V, V_{IH} = +2.4V, limits apply to each of the four channels, when addressed.

Parameter	Description	Test Conditions	Temp	EHA2400/A				EHA2405/A				Units
				Min	Typ	Max	Test Level	Min	Typ	Max	Test Level	
FPBW1	Full Power Bandwidth (Notes 2, 8, 9)		25°C	300	500		IV	300	500		IV	kHz
FPBW2	Full Power Bandwidth (Notes 2, 4, 9)		25°C	95	125		I	95	125		I	kHz
GBW1	Gain Bandwidth (Note 8)		25°C	20	40		IV	20	40		IV	MHz
GBW2	Gain Bandwidth (Note 4)		25°C	4	8		IV	4	8		IV	MHz
t _{r1}	Rise Time (Notes 4, 10)		25°C		20	45	I		20	50	I	ns
OS	Overshoot (Notes 4, 10)		25°C		25	40	I		25	40	I	%
SR1	Slew Rate (Notes 8, 11)		25°C	20	30		IV	20	30		IV	V/ μ s
SR2	Slew Rate (Notes 4, 11)		25°C	6	8		I	6	8		I	V/ μ s
t _s	Settling Time (Notes 4, 12)		25°C		1.5	2.5	IV		1.5	2.5	IV	μ s
t _{sd}	Output Delay (Note 6)		25°C		100	250	IV		100	250	IV	ns

Note 1: Unselected channels have approximately the same input parameters.

Note 2: V_{OUT} = $\pm 10V$.

Note 3: Two tests are performed. V_{CM} = 0V to +5V and V_{CM} = 0V to -5V.

Note 4: A_V = +1, C_{COMP} = 15 pF, R_L = 2 k Ω , C_L = 50 pF.

Note 5: Two tests are performed. V₊ = +15V, and V₋ is changed from -10V to -20V. V₋ = -15V, and V₊ is changed from +10V to +20V.

Note 6: To 10% of final value; output then slews at normal rate to final value.

Note 7: Unselected input to output; V_{IN} = $\pm 10V$.

Note 8: A_V = +10, C_{COMP} = 0, R_L = 2 k Ω , C_L = 50 pF.

Note 9: Full power bandwidth based on slew rate measurement using: FPBW = SR/(2 π V_p).

Note 10: V_{OUT} = $\pm 200\text{ mV}$.

Note 11: V_{OUT} = $\pm 5V$.

Note 12: To 0.1% of final value.

1

EHA2400 Series

4 Channel Programmable Amp

Typical Performance Curves

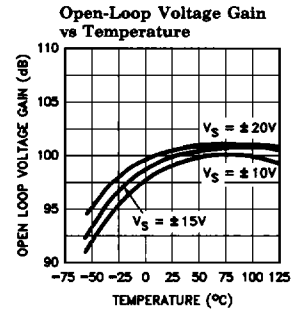
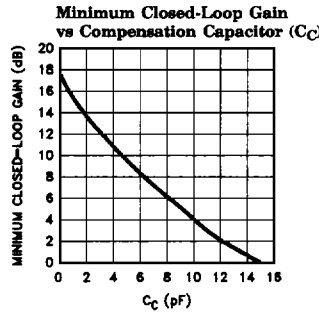
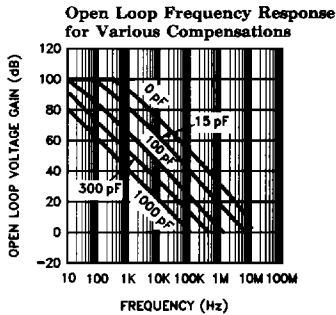
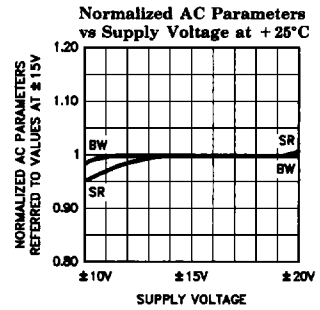
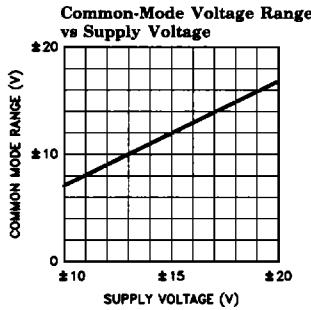
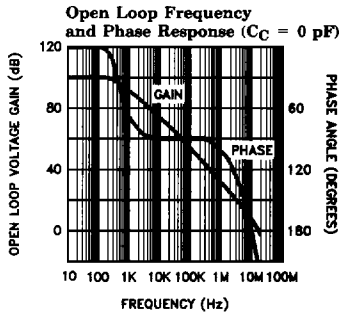
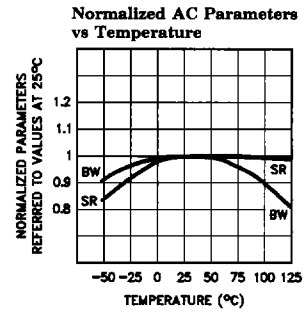
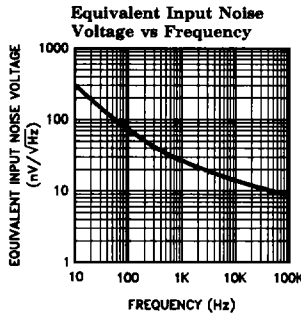
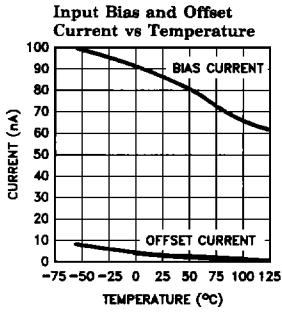

2400-2

EHA2400 Series

4 Channel Programmable Amp

EHA2400 SERIES

1

Typical Performance Curves — Contd.

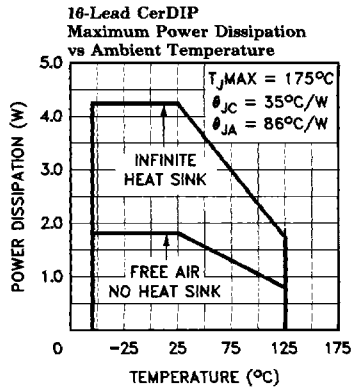
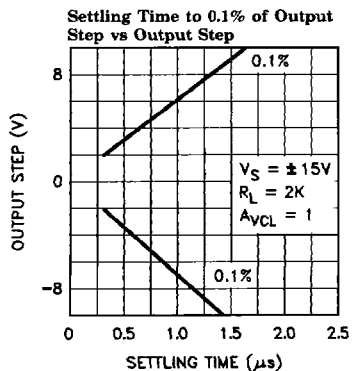
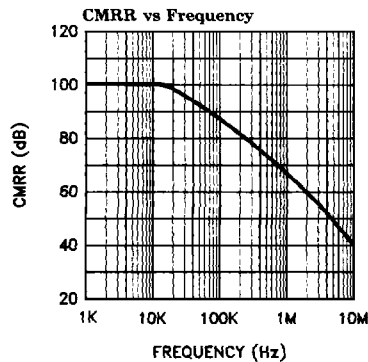
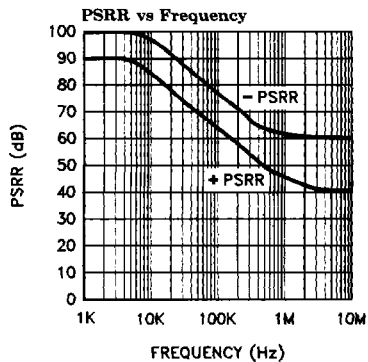
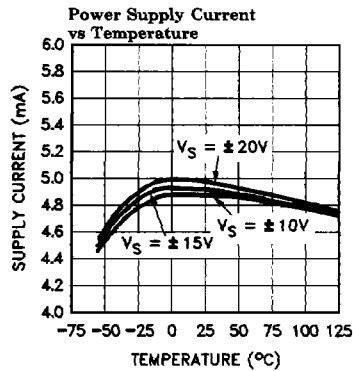
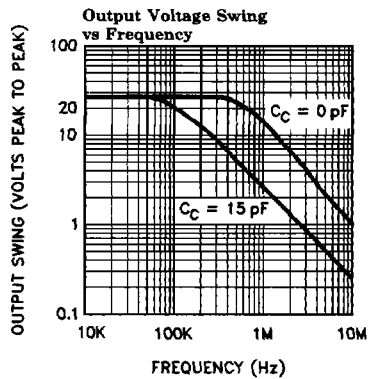

2400-3

EHA2400 Series

4 Channel Programmable Amp

Typical Performance Curves — Contd.

Output Delay—Channel to Channel
for 100 mV step. Measured from 50%
of Switching Signal to 10% of final
value of Output Signal.

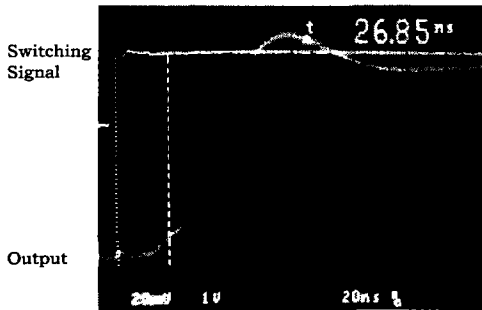

Horizontal = 20 ns/div.
Vertical = 1 V/div. (Switching Signal)
20 mV/div. (Output)

2400-4

Transient Response

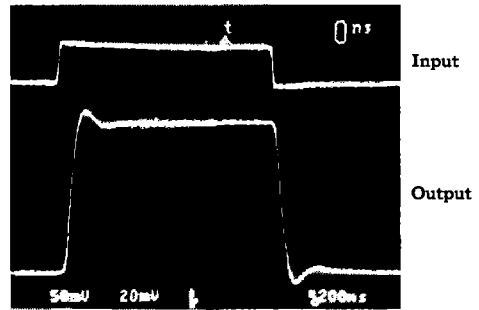

Horizontal = 200 ns/div.
Vertical = 20 mV/div. (Input)
50 mV/div. (Output)

2400-5

Slew Rate

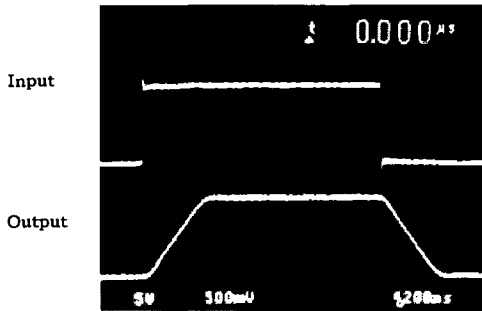

Horizontal = 200 ns/div.
Vertical = 500 mV/div. (Input)
5 V/div. (Output)

2400-6

Slew Rate and Transient Response

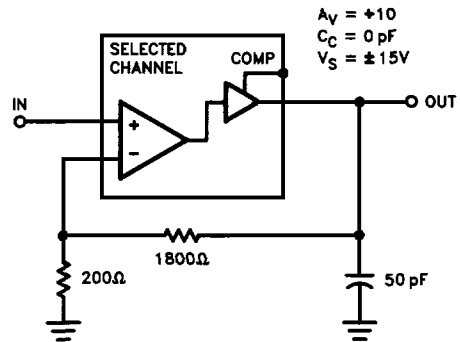

2400-7